



WELCOME TO FLEETWOOD

Before You Begin

We are proud of our 58+ year history as a California-based window and door manufacturer. In a time when others are making products in foreign countries, Fleetwood remains true to its essential purpose as an American company, employing American workers making quality products.

We believe we are helping support the American dream of success by relying upon God and this country's ingenuity and work ethic, which has made the United States of America the greatest country in the world. Our focus is to innovate, not imitate.

You will discover that we continue to blaze a trail of top quality and innovative design, like our patented Archetype door latch system.

We appreciate the amount of time it takes to properly research windows and doors. We believe you will discover that Fleetwood offers much more value than any other window and door company. If possible, visit our factory or a dealer showroom. Once you have operated one of our life size doors (the bigger the better!) you will understand our reputation.

TABLE OF CONTENTS

General	Page
The Little Things	2
Benefits Of Aluminum	3
Green & Sustainable	52
Factory & Showroom	53

Doors	Content	Page
Sliding Door Comparison Chart		7
Multi-Slide/Pocket	Series 4070-T Thermal Frame	8–9
Multi-Slide/Pocket	Series 3050	10–11
Multi-Slide/Pocket	Series 3070-T Thermal Frame	12–13
Multi-Slide/Pocket	Series 3070	14–15
Traditional Sliding	Series 3000-T Thermal Frame	16–17
Traditional Sliding	Series 3000	18–19
Hinged Door Comparison Chart		21
Pivot Door	Series 4400-T Thermal Frame	22–23
Hinged Door	Series 3900-T Thermal Frame	24–25
Hinged Door	Series 3200-T Thermal Frame	26–27
Folding Door	Series 3600-T Thermal Frame	28–29

Windows	Content	Page
Window Comparison Chart		33
Casement, Awning & Hopper	Series 450-T Thermal Frame	34–35
Casement, Awning & Hopper	Series 250-T Thermal Frame	36–37
Window-Wall Fixed System	Series 4800-T Thermal Frame	38–39
Window-Wall Fixed System	Series 3800-T Thermal Frame	40–41
Horizontal Sliding & Single Hung	Series 530-T Thermal Frame	42–43

Product Options	Page
Aluminum Finishes	44–45
Steel Look Options	46–47
Door Hardware	48–49
Window Hardware	50–51

THE "LITTLE" THINGS



ARCHETYPE ROLLING SYSTEM

Made in the USA with **certified Swiss** precision bearings and European 440C stainless. Hand assembled with 100% SPC (Statistical Process Control) and visually inspected. Strict proprietary tolerances achievable by only the finest global bearing manufacturers.

HRC 58 bearing hardness compared to HRC 40 industry standards (below 52 creates metallic particles acting as a grinding paste). Each bearing contains a special low friction contact seal with Lifetime lubricant. All rollers come with a Lifetime warranty. For more information, ask our dealer for a copy of *Archetype Rolling System*.

ARCHETYPE & ARCHETYPE NARROW LOCKING SYSTEM

Made in the USA from high-grade stainless steel. The faceplates are constructed of #300 stainless steel and then electro-polished for the highest possible coastal protection. The latch hook(s) are comprised of laminated 6 ply stainless steel and each pull is cast with #316 stainless steel and electro-polished. For more information, ask our dealer for a copy of *Archetype Locking System*.



BENEFITS OF ALUMINUM

THERE ARE NUMEROUS REASONS TO CHOOSE ALUMINUM WINDOWS AND DOORS.



CRISP, LINEAR SHAPES

Aluminum can easily be designed with great intricacy, which provides narrow sightlines, allowing the door or window to blend into the architecture rather than overpower it. For example, the Series 3070 is available 22' tall and the vertical sightline is ONLY 2-1/8".

LOW MAINTENANCE

Without question, aluminum is the most durable and easily maintained window and door material. We encourage you to review our Care & Maintenance Instructions, as well as our Lifetime Warranty.

FIRE HEAT RESISTANCE

Products designed to resist the impingement of flames are often made of steel, which has limits in function and design. In contrast, aluminum, though not fire proof, offers diverse design elements with practical fire performance. Aluminum windows and doors help maintain firewall integrity because extruded aluminum retains its form at over 1000°F and is non-combustible. Heat and flames quickly destroy most other windows. The urban wild fire building codes are addressing some of these practical realities and seem to be leaning toward aluminum or steel as the preferred building material.

IMPACT PRODUCT LINE

Fleetwood offers a product line designed for markets requiring impact tested products. For more information, visit the Products section online.

ENERGY COMPLIANCE

The **SHGC** measures heat gain based on direct sun exposure. The lower the number, the less heat (short wave radiation) passes through the window or door. Sunbelt climates should make this value a high priority.

The **U-Factor** measures heat lost through the window or door. Be careful not to apply too much importance to this factor because **the test is done with all seams taped shut**. For more information, see 'Making the Right Choices' on our website.

• NFRC Test Result:

Online test results for each product.

• Weighted Average(s) Per Job:

NFRC data averages provided with each quote.

• Custom Analysis:

Using the same software as the NFRC, Fleetwood provides a true energy result of each custom opening (expect an improvement of 5%-20%).



SLIDING DOORS



DOOR COMPARISON CHART

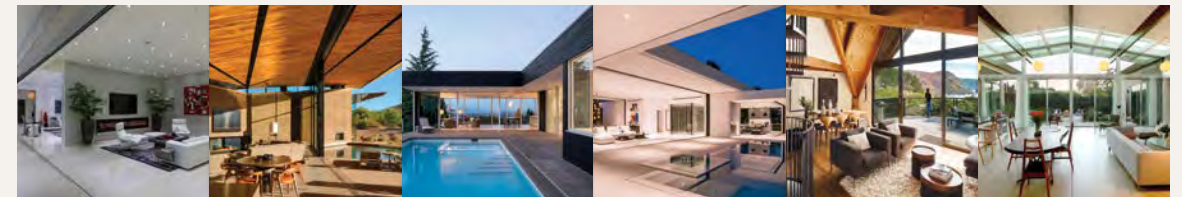

SERIES 4070-T
MULTI-SLIDE
& POCKET DOOR

SERIES 3050
MULTI-SLIDE
& POCKET DOOR

SERIES 3070-T
MULTI-SLIDE
& POCKET DOOR

SERIES 3070
MULTI-SLIDE
& POCKET DOOR

SERIES 3000-T
SLIDING DOOR

SERIES 3000
SLIDING DOOR

USA Made Hardware	•	•	•	•	•	•
Patented Archetype Locking Hardware	•	•	•	•	•	•
Stainless Edge Pull	•	•	•	•	•	•
Stainless Assembly Screws	•	•	•	•	•	•
Archetype Double Latch	•	•	•	•		
Designer Pulls by FSB	•	•	•	•	•	•
A4 (Stainless Quad Rollers)	•					
A3 (Stainless 3" Tandem Rollers)		•	•	•		
A2 (Stainless 2" Tandem Rollers)		•	•	•	•	•
Certified Swiss Precision Bearings	•	•	•	•	•	•
Sub Sillpan (Flush Sill)	•		•	•		
Hidden Track (Flush Sill)		•				
Sill Fillers			•	•		
Head Fillers	•	•	•	•	•	•
Jamb Fillers	•	•	•	•		
Sill Pan	•		•	•	•	•
Thermal Frame	•		•		•	
Integral Nail-Fin Frame	•				•	•
90 Degree Corner-No Post	•	•	•	•		
Custom Angle Corner-No Post		•	•	•		
Curved Glass & Frame		•				
Pocketing/ Multi-Panel Stacking	•	•	•	•		
Flush Stacking Option	•	•	•	•	•	•
High Performance Options		•	•	•	•	•
Divided Lites	•	•	•	•	•	•
Ultravue Screen Mesh	•	•	•	•	•	•
Heavy Duty Screen Frame	•	•	•	•		
Patent(s) Pending	•					

Page 6

Page 8

Page 10

Page 12

Page 14

Page 16

SERIES 4070-T

MULTI-SLIDE & POCKET DOOR

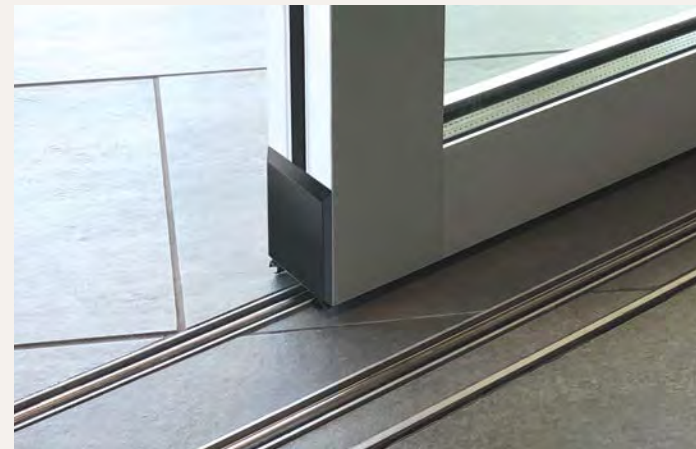

MINIMAL

The 4070-T was designed with two primary intentions: large sizes and a weather performing flush sill. The patent pending sill is a highly engineered sub floor system, which creates a minimal footprint in the finished floor yet still achieves water, air, and energy ratings for residential use.



MASSIVE YET SLIM

The 4070-T is available in 120 square foot panels (up to 1400 lbs), which requires massive frame strength. While achieving the unequaled strength necessary to support these panels, the 4070-T still presents a sleek 2-1/2" vertical sightline and a short bottom rail at 3-1/4" tall.

CONFIGURATIONS

■ Virtually Unlimited Multi-Slide, Pocket and Corner applications.

← MAX PANEL WIDTH	↑ MAX FRAME HEIGHT	EXAMPLE SHGC		EXAMPLE U-FACTOR	
12'	20'	² NFRC 0.21	³ S.P.A. 0.24	² NFRC 0.35	³ S.P.A. 0.28

Elevation View:
XXX Configuration

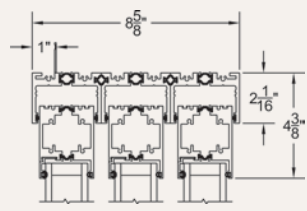

Head

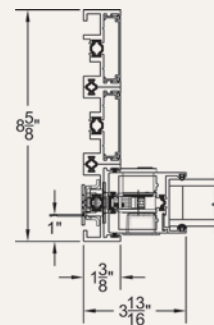
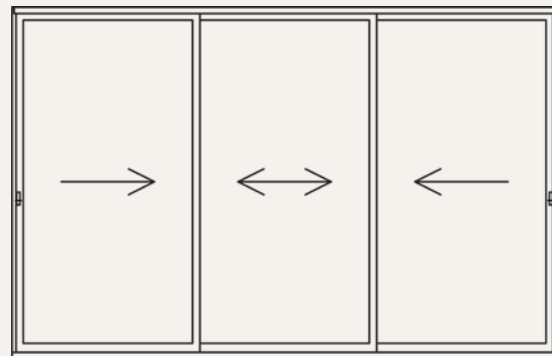

Lock Jamb

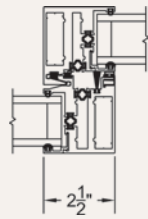

Interlockers

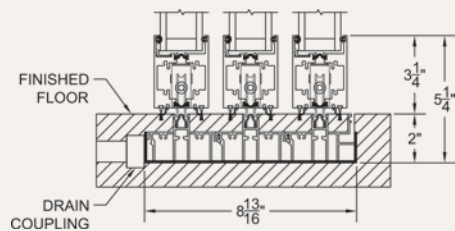

Sill



SMART BUILDING DESIGN

Field conditions were factored into the design of this exceptional door. For instance, the glass can be vertically set in the later stages of construction to protect the glass and facilitate the progress of other trades. Additionally, the patent pending sill is shipped with a cover for the tracks and linear drain for protection during finished floor installation.

PROPRIETARY HARDWARE

The 4070-T is outfitted with Fleetwood designed and manufactured hardware. The A4 roller may resemble copycat rollers in the mass production market but only the A4 uses certified Swiss precision bearings. The slender locking hardware is our patented (Patent # US 8,186,189 B2) Archetype Narrow.



¹Max width and height are not necessarily available in combination.

²Specimen size: Nom. 79" x 79".

³Simulated Performance Alternative size: 216" x 144" XXX using Cardinal 366-i89/Argon glass.

SERIES 3050

MULTI-SLIDE & POCKET DOOR



Photo by Alexander Vertikoff

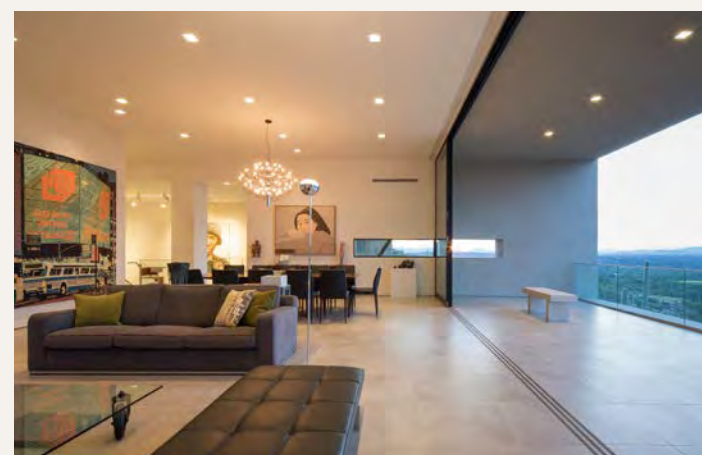

Photo by Stella S. Lee Photography



KITCHEN-TO-PATIO TRACK

The 3050 is a special variant of the Series 3070 as it offers a unique sill. The "Hidden Track" creates an almost invisible transition from the interior to the exterior, while offering modest energy and air performance. Customers can choose from two heights for the desired finished flooring. For higher performing weather and energy needs, consider the Series 4070-T, 3070 or 3070-T doors.

VERSATILE APPLICATIONS

Primarily designed for interior applications, the 3050 is a contemporary lifestyle door, ideal for interior pocket doors, room dividers, and pass-through counters. The completely recessed track provides an ultra clean and unobtrusive appearance at the floor. The profiles are the same as our exterior rated sliding doors, allowing for a unified design throughout the home.

EXCEPTIONAL HARDWARE

All Fleetwood sliding doors come equipped with Fleetwood's proprietary Archetype locking & sliding systems, proudly made in the USA. Our patented locking hardware is offered in two stile widths: Archetype and Archetype Narrow and both are available in brushed stainless or black finishes. As for smooth operation, our A3 roller is made possible with certified Swiss precision bearings and high-grade stainless steel.

CURVED SLIDING DOORS

Fleetwood stands alone in our capability to provide curved sliding glass walls. Our state-of-the-art Delta 60 CNC-I roll bender offers curved doors with a radius as tight as 12' and unlimited widths.

CONFIGURATIONS	MAX PANEL WIDTH	MAX FRAME HEIGHT	EXAMPLE SHGC		EXAMPLE U-FACTOR	
Virtually Unlimited Multi-Slide, Pocket and Corner applications.	10'	18'	² NFRC 0.22	³ S.P.A. 0.23	² NFRC 0.46	³ S.P.A. 0.39

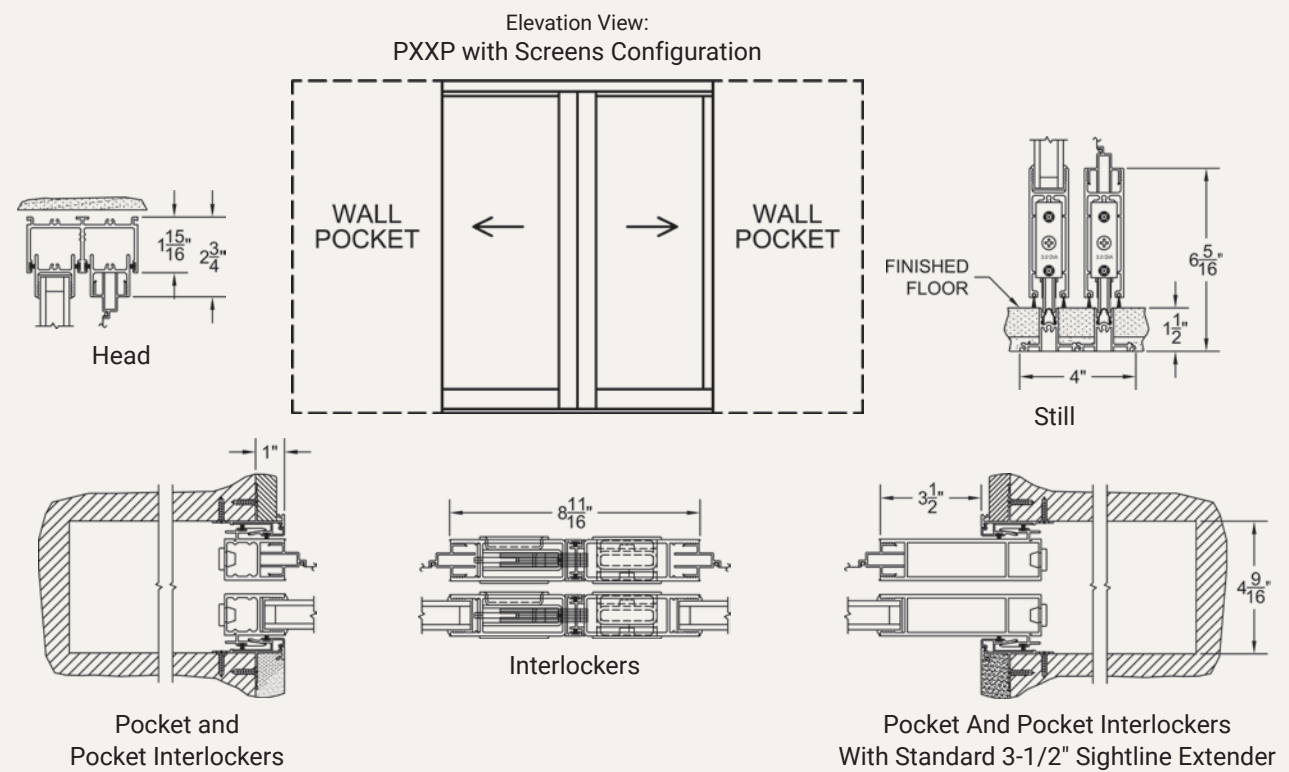

¹Max width and height are not necessarily available in combination.
²Specimen size: Nom. 79" x 79".
³Simulated Performance Alternative size: 120" x 144" PXXP using Cardinal 366-i89/Argon glass.

SERIES 3070-T

MULTI-SLIDE & POCKET DOOR



Photo by Jeremy Bitterman

TYPICAL CONFIGURATIONS

■ Virtually Unlimited Multi-Slide, Pocket and Corner applications.

← MAX PANEL WIDTH	↑ MAX FRAME HEIGHT	☀ EXAMPLE SHGC	❄ EXAMPLE U-FACTOR
8'	12'	² NFRC 0.23 ³ S.P.A. 0.24	² NFRC 0.29 ³ S.P.A. 0.27

Elevation View:
OXX Configuration

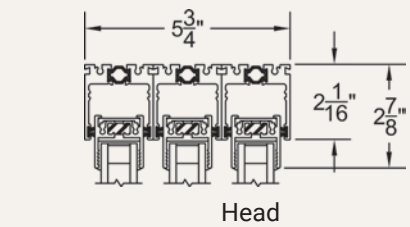

Head

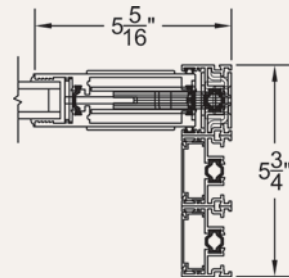
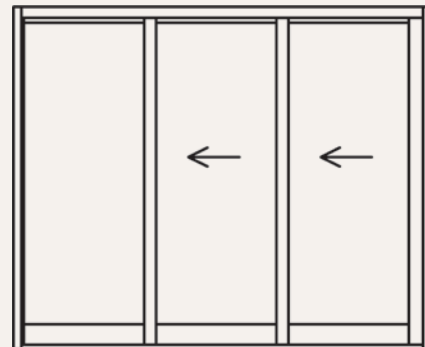

Lock Jamb-Right

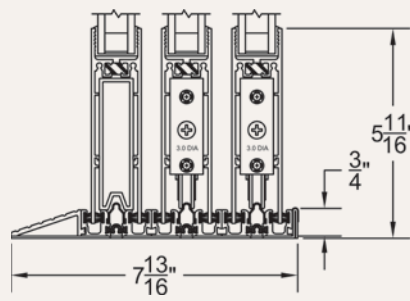

Sill with Riser

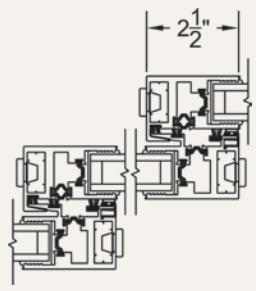

Interlockers

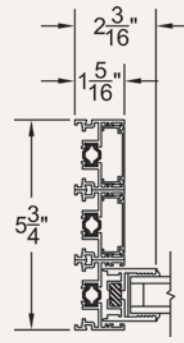

Fixed Jamb-Left



MINIMALISTIC HARDWARE

The standard locking system for the 3070-T is our patented Archetype system. For those desiring even more glass, we offer the optional Archetype Narrow, which is the same latch as the Archetype but with vertical actuation.



NO POST CORNER

Custom extrusions were created to allow 90° corner doors and odd angle corner doors without the need for a post or jamb. The result is the strongest and most attractive corner door on the market. Imagine the transformation of your stunning view as you maximize space and minimize barriers between the inside and outside.



FROST CLIMATE EXTRUSIONS

The 3070-T was designed to emulate the Series 3070, but with added accommodations for colder climates. Each aluminum extrusion includes an integral thermal barrier that reduces the thermal conduction of the exterior climatic temperature to the interior. The resulting door system boasts improved energy performance that complies with the strictest energy codes in North America and retains a highly attractive aesthetic.

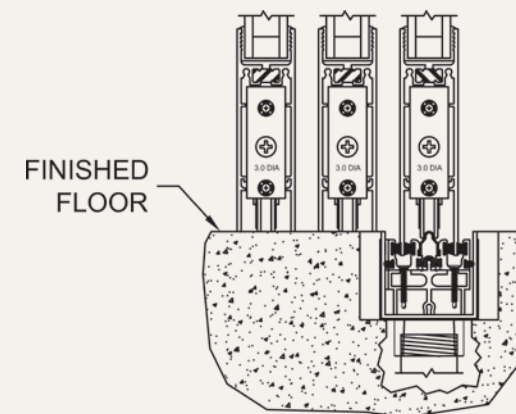

SUB SILLPAN

The Sub Sillpan is proprietary to Fleetwood. It allows for transition flush flooring and hurricane water performance. Customers may choose a jamb-to-jamb track or a staggered design, as shown here. Builders appreciate the threaded couplings, which offer a variety of placement locations.

¹Max width and height are not necessarily available in combination.

²Specimen size: Nom. 79" x 79".

³Simulated Performance Alternative size: 120" x 144" OXX using Cardinal 366-i89/Argon glass.

SERIES 3070

MULTI-SLIDE & POCKET DOOR



Photo by Art Gray

TYPICAL CONFIGURATIONS

Virtually Unlimited Multi-Slide, Pocket and Corner applications.

MAX PANEL WIDTH	MAX FRAME HEIGHT	EXAMPLE SHGC		EXAMPLE U-FACTOR	
10'	18'	² NFRC 0.22	³ S.P.A. 0.24	² NFRC 0.47	³ S.P.A. 0.32

Elevation View:
OXXX Configuration

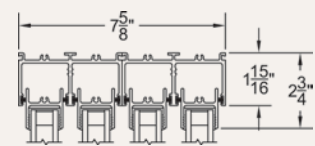
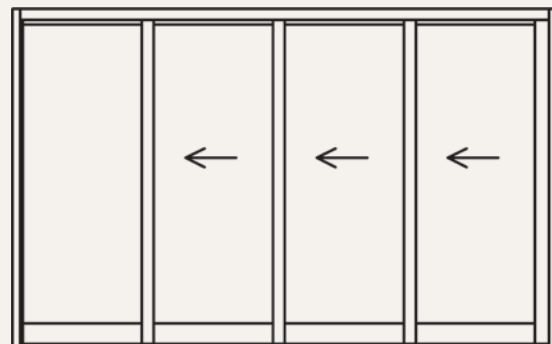

Head

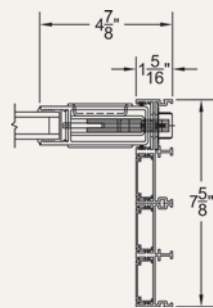

Lock Jamb

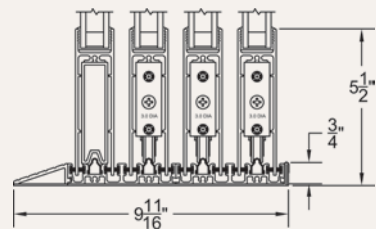

Sill with Riser

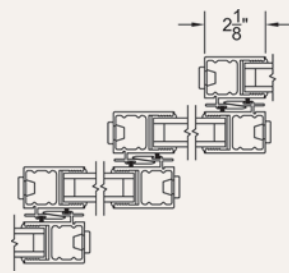

Interlockers

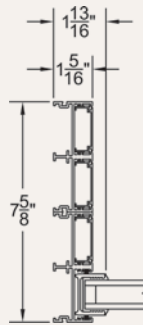

Fixed Jamb

¹Max width and height are not necessarily available in combination.

²Specimen size: Nom. 79" x 79".

³Simulated Performance Alternative size: 288" x 130" OXXX using SNX62/27-IS20/Argon Warm Edge glass.

ATTENTION TO DETAIL

The 3070 is loaded with features that accentuate its beauty and purposeful design. For example, the frame fillers conceal the stainless steel installation screws, enhance weather performance, and guard against sand, dirt, and snow.

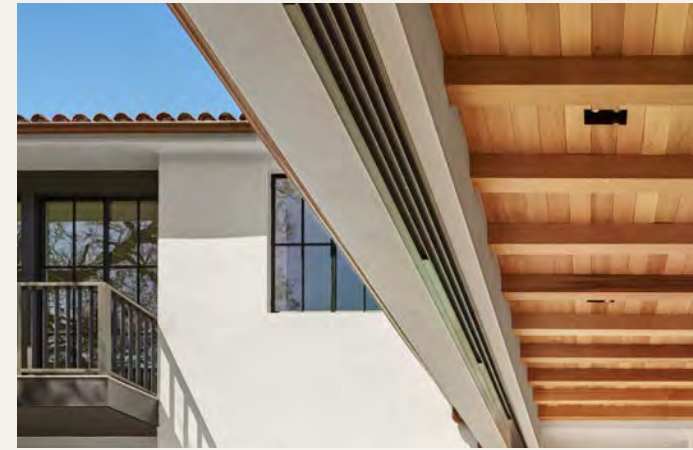

CUSTOMIZABLE FEATURES

The 3070 can be customized to accommodate a wide variety of aesthetics and purposes. Each of the two lock stile choices offer unique design and ergonomics based on our patented Archetype technology. Additionally, customers can also choose between our A3 and A2 rollers, each of which provides a distinct sightline and panel size capability.



WEATHER RATED FLUSH SILL

The optional Sub Sillpan allows for a continuous finished floor, similar to the Series 3050 Hidden Track, but with tested weather performance. A staggered track design achieved a 6 PSF water test result, which is equal to that of a high-rise door.

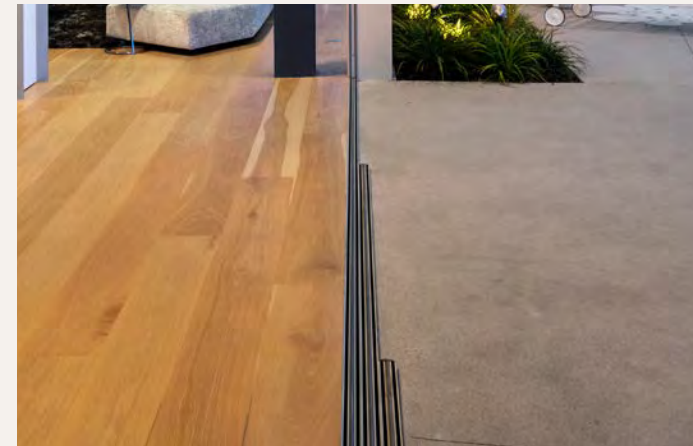

DESIGN FLEXIBILITY

Be limited only by your imagination and stay true to the design intent with virtually unlimited choices in panel arrangement. The 3070's robust offering includes: no-post inside and outside corners, curved doors, pocketing systems, and traditional configurations.



SERIES 3000-T

SLIDING DOOR



Photo by Joe Fletcher

TYPICAL CONFIGURATIONS

OX, XO, OXO, OOX, XOO, XOX, OXXO, XOOX.

MAX PANEL WIDTH	MAX FRAME HEIGHT	EXAMPLE SHGC		EXAMPLE U-FACTOR	
6'	12'	² NFRC 0.21	³ S.P.A. 0.23	² NFRC 0.35	³ S.P.A. 0.27

Elevation View:
OXIXO Configuration

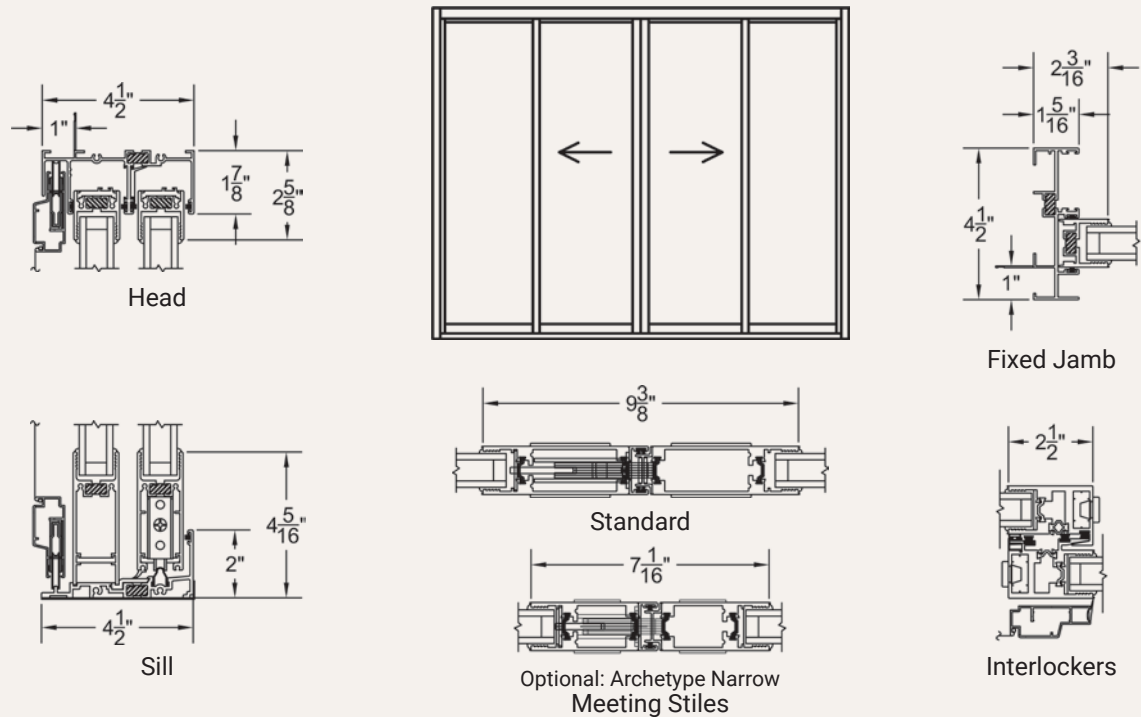

¹Max width and height are not necessarily available in combination.

²Specimen size: Nom. 79" x 79".

³Simulated Performance Alternative size: 192" x 120" OXIXO using SNX62/27-IS20/Argon Super Spacer glass.



THERMAL FRAME EXTRUSIONS

Multi-slide/pocket door systems (3070, 3070-T) are not always needed so we offer the 3000-T for more traditional configurations in colder climates. Using modern technology, each extrusion is engineered to balance aesthetics and performance. The engineering strength is obvious at each touch, and detail-minded consumers appreciate the basic invisibility of the thermal barrier.



PROPRIETARY TRACK SYSTEM

All Fleetwood sliding doors come with an engineered track and roller union. Other doors have an aluminum track, which eventually wears down, or a track cover that comes loose. In contrast, Fleetwood's track inserts becomes more stable as weight bears down and the A2 roller concavity is in perfect harmony to the convex shape of the proprietary insert.



CUSTOMIZATION

The 3000-T can be configured and paired with other products. For example, the false jamb feature allows a center sliding panel or can be used as an "in frame" mullion between a series of fixed panels to create a large opening, i.e. 0000X0000. Additionally, the 4-1/2" frame depth allows the door to be seamlessly mulled to Series 3800-T transoms and fixed windows.

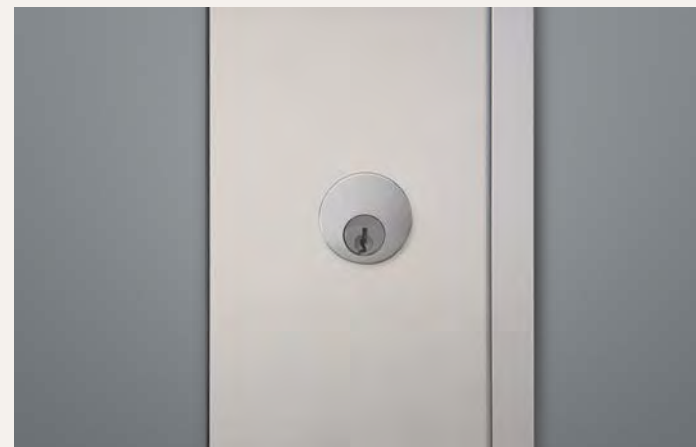

OPTIONAL FEATURES

As with the other Fleetwood sliding doors, the 3000-T is available with several features. High performance verticals can be added to bolster wind load; glass dividers (TDL) can be configured to follow key building lines; an optional sleek, commercial-grade keyed cylinder offers maximum security; and several hardware options accommodate a wide range of needs and aesthetics (see Series 3000).

SERIES 3000

SLIDING DOOR



TRADITIONAL PATIO DOOR

Multi-slide/pocket door systems are not always needed or feasible, so we offer the 3000 and 3000-T for more traditional configurations. These doors fulfill the practical needs of a traditional patio slider but in massive sizes and with much of the same hardware as the Series 3070. Since the vertical sightlines match the multi-slide doors, both blend well in the same project.



THRESHOLD CHOICES

The 3000 comes standard with a 1-7/8" tall threshold, but the most popular is the 1-1/4", though water performance is lower. If higher water performance is required, we offer a third sill height option at 3".

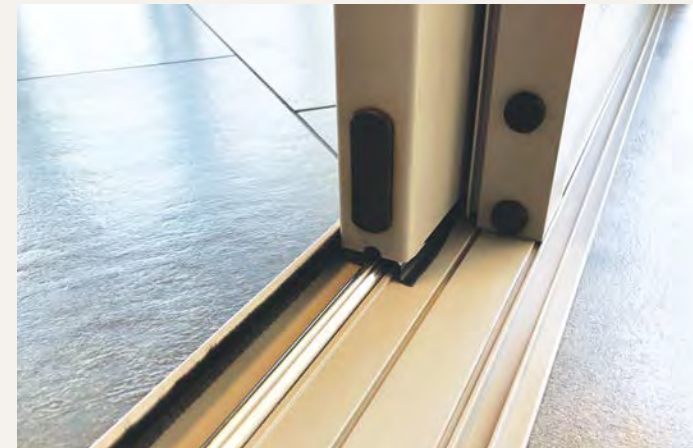

TYPICAL CONFIGURATIONS

OX, XO, OXO, OOX, XOO, XO, OXXO, XOOX.

← MAX PANEL WIDTH	↑ MAX FRAME HEIGHT	EXAMPLE SHGC		EXAMPLE U-FACTOR	
17'	14'	² NFRC 0.22	³ S.P.A. 0.24	² NFRC 0.47	³ S.P.A. 0.35

Elevation View:
OXOL Configuration

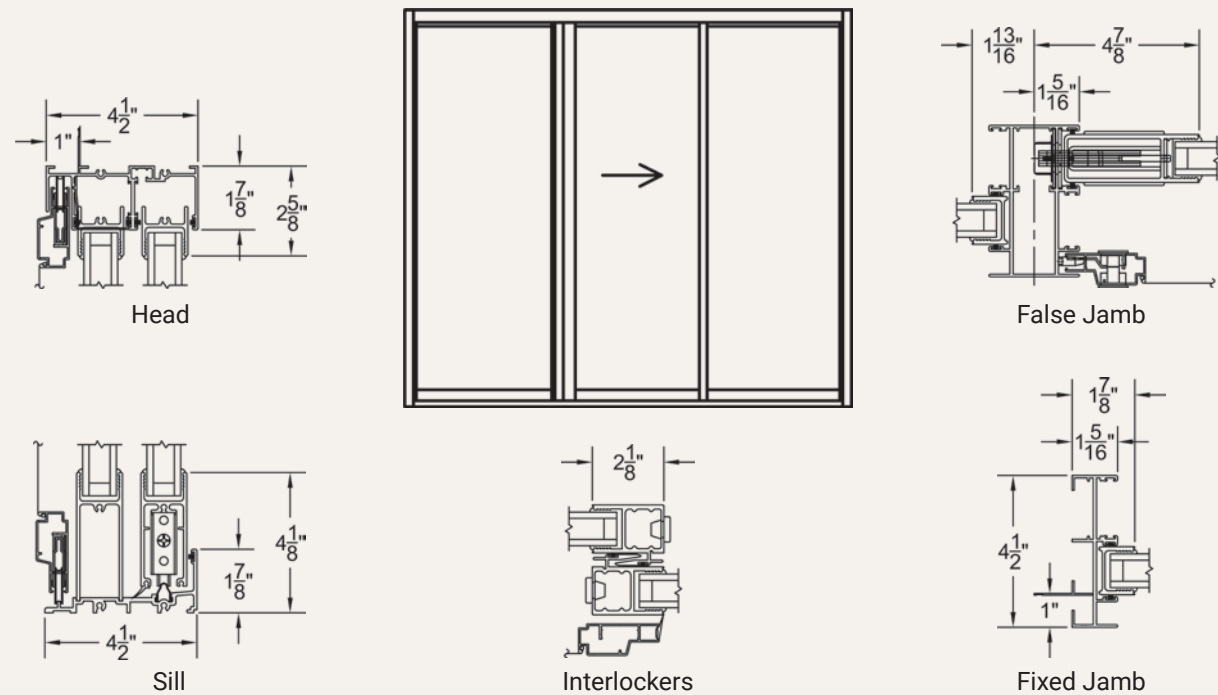

HANDLE CHOICES

The 3000 comes standard with our patented Archetype locking hardware and recessed pull. If a larger or protruded pull is desired, we offer the Archetype actuator only paired with an FSB pull, from which there is a large variety to choose. For those seeking slimmer sightlines, we offer the Archetype Narrow hardware.

SCREEN EXCELLENCE

To most homeowners, screens are a source of irritation because they function poorly and disrupt the view. All Fleetwood products come standard with advanced screen mesh technology by Pfizer Wire. Specifically, we use the nearly transparent Ultravue mesh. It is an ideal complement to our sturdy extruded screen frame, which is easy to operate and is made to last for life.

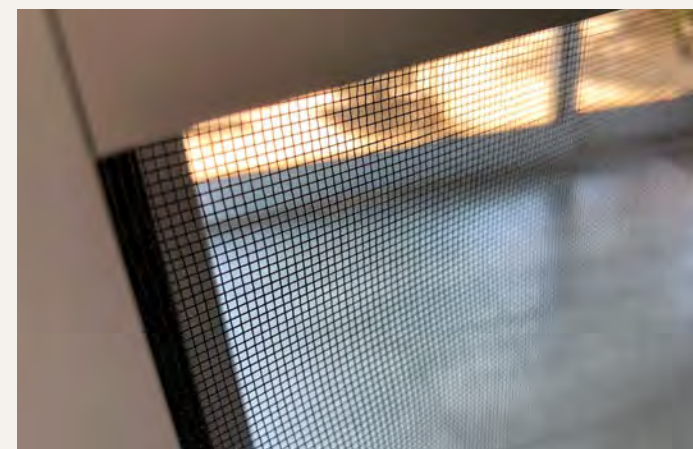

¹Max width and height are not necessarily available in combination.

²Specimen size: Nom. 79" x 79".

³Simulated Performance Alternative size: 180" x 130" OXO using SNX62-IS20/Argon Warm Edge glass.

HINGED DOORS



DOOR COMPARISON CHART



SERIES 4400-T
PIVOT DOOR

SERIES 3900-T
LUXURY HOME
HINGED DOOR

SERIES 3200-T
NARROW STYLE
HINGED DOOR

SERIES 3600-T
FOLDING DOOR

Stainless Latch/Lever	•	•	•	•
Stainless Assembly Screws	•	•	•	•
Stainless Adjustable Carriers				•
Multi-Point Latch Hardware	•	•		
Designer Levers/Pulls by FSB	•	•	•	•
Adjustable Hinges		•	•	
In-Rail Closer	•			
Floor Closer	•			
Flush Guide Sill				•
Weather Performing Flush Sill	•			
1/2" Height Sill		•	•	
Sill Pan		•	•	•
Thermal Frame	•	•	•	•
Integral Nail-Fin Frame	•	•	•	•
Keyless Entry	•	•		
High Performance Features		•		
Divided Lites	•	•	•	•
Patent(s) Pending	•			

Page 20

Page 22

Page 24

Page 26

SERIES 4400-T

PIVOT DOOR

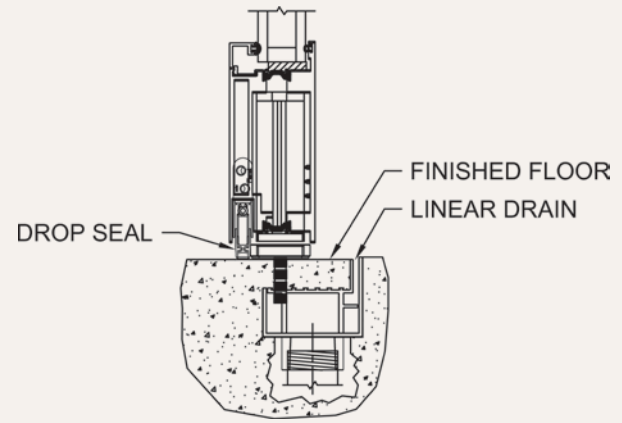

RESIDENTIAL DESIGN
 The first of its kind, the 4400-T breaks serious ground as a weather and energy rated pivot door designed for luxury residential applications. It marries the clean, contemporary design demanded by modern architecture with the performance required by an entrance door. Engineered weather barriers and a concealed drop seal in the bottom rail secure the interior against air and debris infiltration.



FLOOR-THROUGH-DOOR SILL
 The same patent pending sill design of the Series 4070-T has been engineered for the Series 4400-T. Specifically, with the In-Rail closer (Fritsurgens), the finished floor of the home is part of the pivot door sill, which ONLY reveals a thin jamb-to-jamb slot drain. The end result is a gorgeous flow of interior floors that blurs into the outdoors. The pivot anchor for this closer requires a minimal 1-3/16" floor penetration, making the door feasible for upper floors.

CONFIGURATIONS	MAX PANEL WIDTH	MAX FRAME HEIGHT	EXAMPLE SHGC	EXAMPLE U-FACTOR
1L2R, 3L2R, 4L1R, 3L, 3R, 4L4R.	160"	180"	Pending	Pending

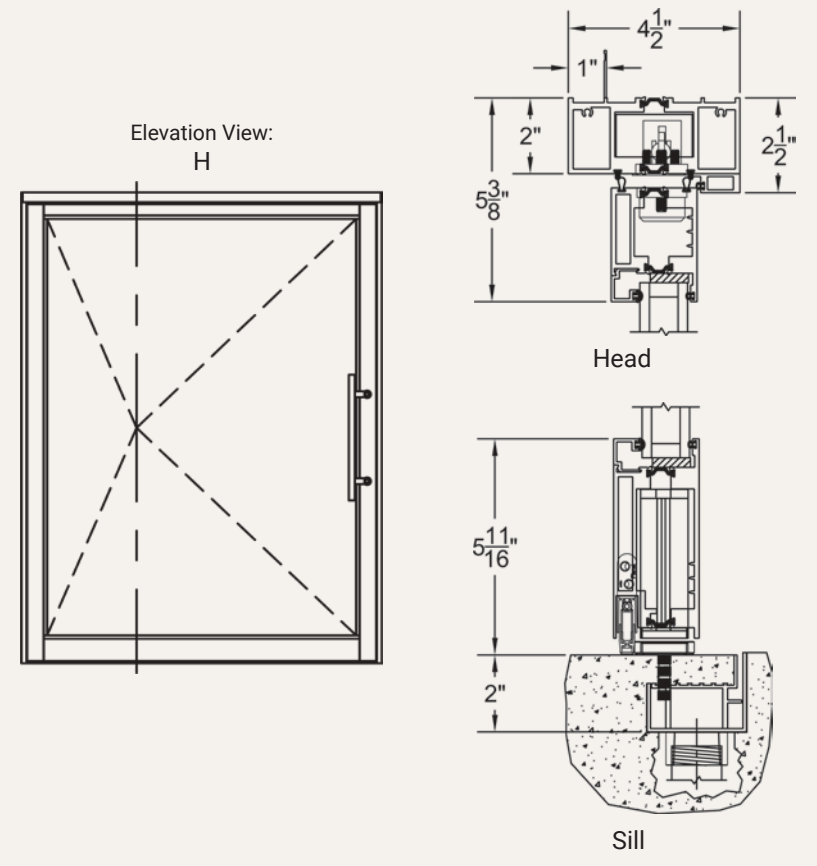

GO BIG
 The strength of the 4400-T allows for incredible sizes that deliver big in both function and drama. Think 15' tall, 1100 lbs. panels with Fleetwood's signature minimal sight-lines and smooth operation.



DESIGN FLEXIBILITY
 To suit varied design and operation needs, the 4400-T is offered with several hardware choices. The standard is an integrated 5-point latching system on a 4" stile operated by an FSB lever. Another option utilizes our proprietary Archetype Narrow hardware on a 3.5" stile operated by an FSB pull.

*Max width and height are not necessarily available in combination.

SERIES 3900-T

LUXURY HOME HINGED DOOR



WORLD CLASS HARDWARE & KEYLESS ENTRY

Functional and beautiful, the 3900-T comes standard with a 5-point system which is actuated with a single lever, and secured with a robust deadbolt. Homeowners can choose from an assortment of FSB levers in various shapes and finishes. As an option, the door is available with an electronic 3-point keyless entry and locking system.



VERSATILE OPTIONS

Frame: The 4-1/2" frame depth allows for field combinations (side lites, transoms, etc.) with other Fleetwood products. **Fixed Side Lite:** Available in a wide or narrow style. **Hopper Insert:** Vents or fixed panels offer the insertion of a hopper (inswing) vent. **Orientation:** Available in-swing or out-swing. **Sill Choices:** Depending on foot traffic and weather needs, the 3900-T is offered in 1/2" or 1-1/2" sill heights.

TYPICAL CONFIGURATIONS

■ H, HH, OH, OOH, OHO, O/HH.

MAX PANEL WIDTH	MAX FRAME HEIGHT	EXAMPLE SHGC	EXAMPLE U-FACTOR
55.875"	144"	² NFRC 0.3 ³ S.P.A. 0.37	² NFRC 0.38 ³ S.P.A. 0.27

Elevation View:
HH Configuration

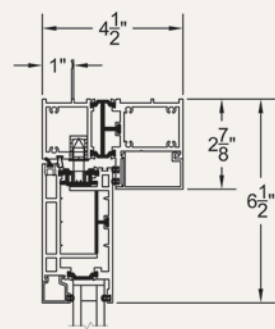

Head

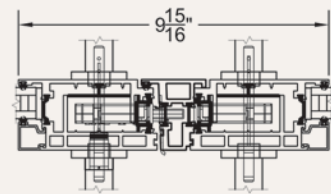
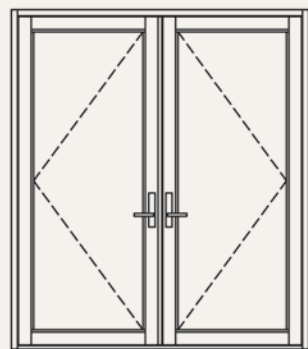

Astrgal

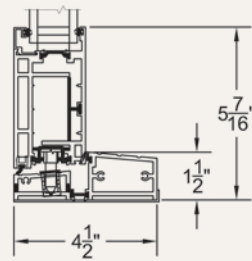

Sill

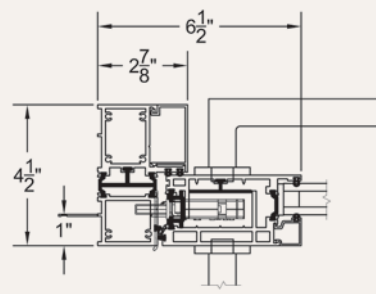

Lock Jamb

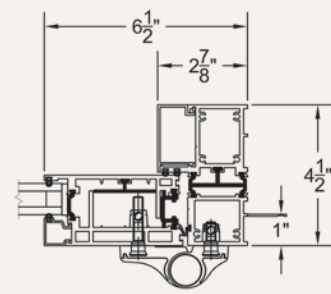

Hinge Side Jamb

²Specimen size: Nom. 38" x 82".

³Simulated Performance Alternative size: 96" x 120" HH using Cardinal 180/Argon/180/Argon/i89 triple glazing.



OUTSTANDING SIZES

Designed for large openings, the 3900-T boasts superior strength with panels as large 4-1/2' x 12'. Such sizes are possible as a result of the extra aluminum in each extrusion and the corner bolstering. We use a highly engineered proprietary assembly unlike anything in the industry, complemented by Savio 3-way adjustable hinges.



THERMAL TECHNOLOGY

The 3900-T thermal barrier is a modern strut consisting of rigid structural polyamide. Each strut is mechanically fused to two separate aluminum shapes to form one extrusion. The result is a significantly minimized thermal conduction of the exterior climatic temperature to the interior. We use this technology because it offers design flexibility without compromising thermal performance.

SERIES 3200-T

NARROW STYLE HINGED DOOR



Photo by Lara Swimmer

TYPICAL CONFIGURATIONS

■ H, HH, OH, OOH, OHO.

← MAX PANEL WIDTH	↑ MAX FRAME HEIGHT	☀ EXAMPLE SHGC	❄ EXAMPLE U-FACTOR
40"	108"	² NFRC 0.14 ³ S.P.A. 0.15	² NFRC 0.34 ³ S.P.A. 0.29

Elevation View:
H Configuration

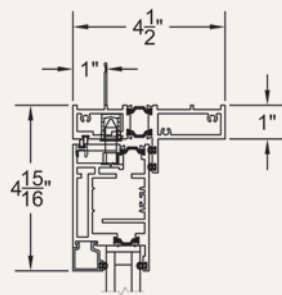
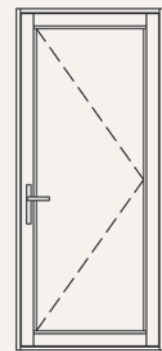

Head

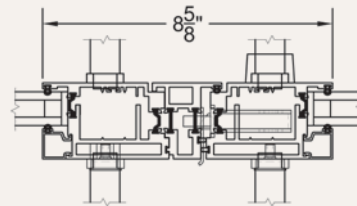

Astrgal
(Paired Doors)

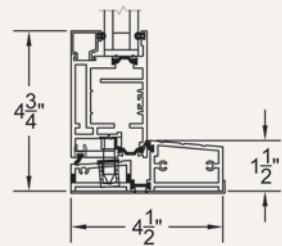

Sill (Outswing)

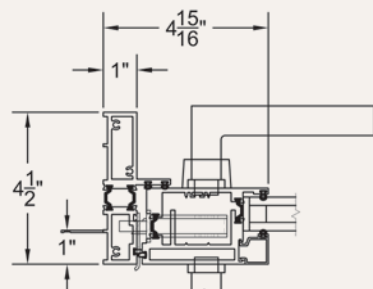

Lock Jamb

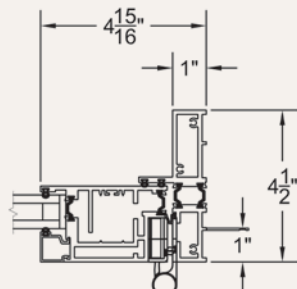

Hinge Side Jamb

²Specimen size: Nom. 38" x 82".

³Simulated Performance Alternative size: 72" x 108" HH using SNX62/Argon/SNX62/Argon/IS20 Warm Edge triple glazing.



STEEL LOOK

The 3/4" Steel Look SDL and Lockbox simulate a classic steel hinged door without the cost and challenges of steel. The Steel Look package is complete when combined with the 250-T and 3800-T with Tiered Stops.

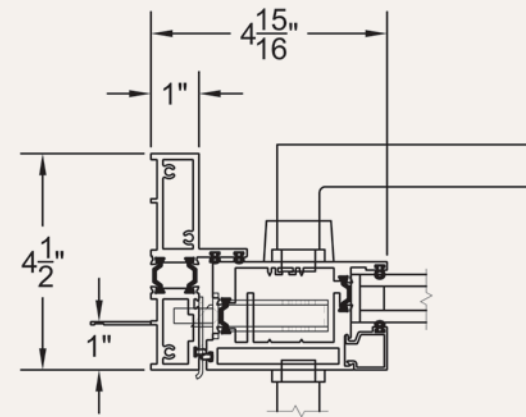

SLENDER YET STRONG

The 3200-T boasts a jamb profile of less than 4" after the frame is buried. Additionally, the horizontal rails have been reduced to provide the least sightline possible. Though slim, the 3200-T is a bulwark door with its heavy aluminum walls and a corner assembly similar to the 3900-T.

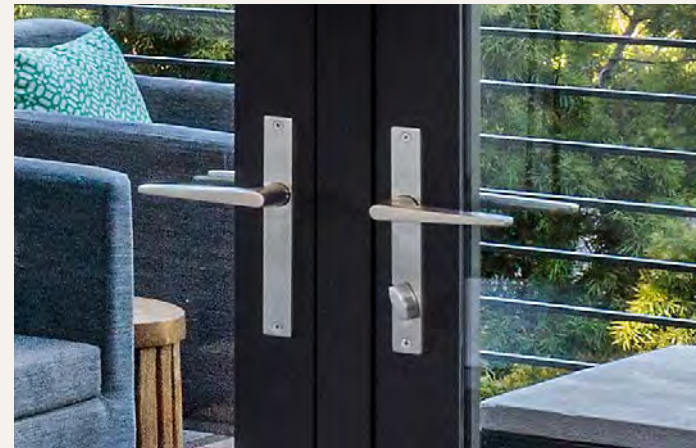

MINIMALIST HARDWARE

The FSB hardware selected for the 3200-T has a slimmer handle plate than the Series 3900-T, but allows the same handle options. The door self-latches when closed and is secured with a dead bolt. The passive panel in a pair comes with a flush mounted lever that operates two shoot bolts.



ADJUSTABLE HINGES & LARGE SIZES

Each operable panel is equipped with four adjustable hinges (horizontal and vertical) that are mortised into the frame. Though slender in profile, the hinges easily support panels as large as 40" x 108".

SERIES 3600-T

FOLDING DOOR



CONFIGURATIONS	MAX PANEL WIDTH	MAX FRAME HEIGHT	EXAMPLE SHGC	EXAMPLE U-FACTOR
1L2R, 3L2R, 4L1R, 3L, 3R, 4L4R.	3.5'	12'	0.38 ² NFRC	0.28 ² NFRC

Elevation View:
1L3R

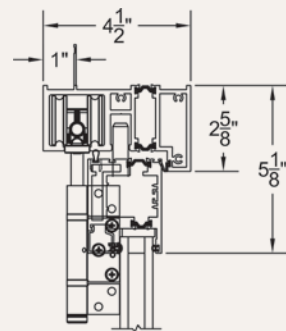

Head

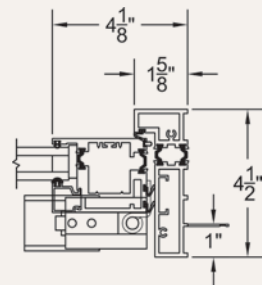

Pivot Jamb

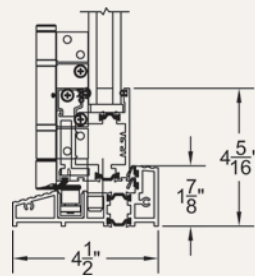

Standard

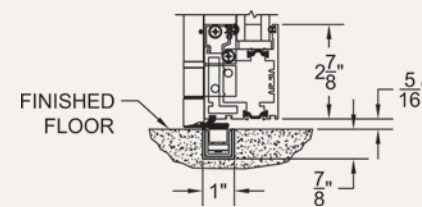

Optional: Flush Sill Guide
Sill

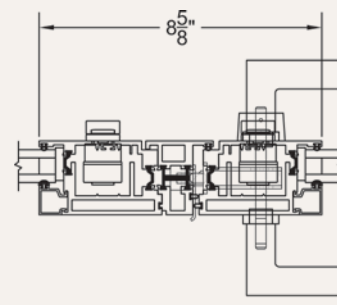

Meetings Stiles
(Integral Hinged Door)

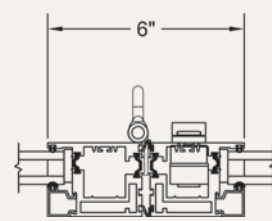

Meetings Stiles
(With Hinged Handle & DPL)

¹Max width and height are not necessarily available in combination.
²Specimen size: Nom. 75" x 82".

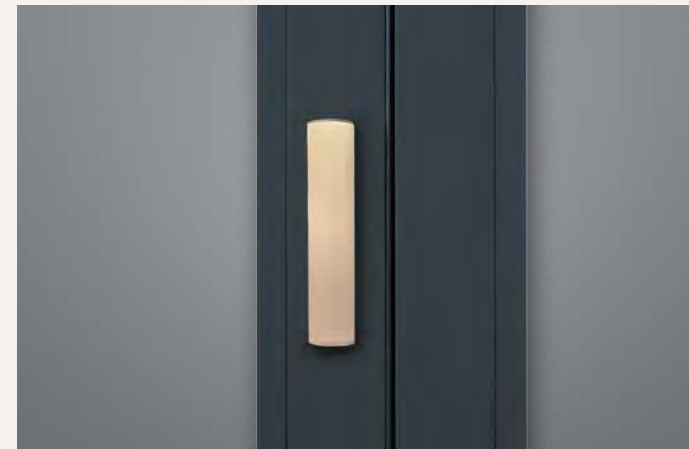

STAINLESS DUAL POINT LOCK

Every folding pair comes standard with our stainless steel Dual Point Lock (DPL). Each DPL throws two stainless steel shoot bolts in the respective tracks to offer high security. Its modern design is an ideal complement to the 3600-T.



COASTAL PROJECTS & ZERO EDGE CORNERS

Most folding doors on the market are offered with hardware that will fail in salt air. In contrast, the 3600-T is designed for such environments. The Dual Point Lock, carriers, hinges, and locking hardware provide longevity in the most extreme conditions. To help expand amazing coastal views, we offer a 90-degree corner configuration with NO vertical posts.



INTEGRATED PASSAGE DOOR

Customers can insert a hinged door within a folding wall. The locking hardware chosen for such doors is FSB, selected for its style and exceptional performance.



CARRIERS

The 3600-T glides on Brio carriers, which is the most current folding door technology. Each intermediate panel has four high performance wheels with two side thrust precision bearings. These four wheels provide unparalleled stability, as well as smoother, quiet operation. Additionally, each wheel is concaved to improve tracking.



WINDOWS



WINDOW COMPARISON CHART



SERIES 450-T
CASEMENT, AWNING & HOPPER

SERIES 250-T
CASEMENT, AWNING & HOPPER

SERIES 4800-T
WINDOW-WALL FIXED SYSTEM

SERIES 3800-T
WINDOW-WALL FIXED SYSTEM

SERIES 530-T
HORIZONTAL SLIDER & SINGLE HUNG

USA Made Latch	•				•
Archetype Window Hardware	•				•
Stainless Assembly Screws	•	•	•	•	•
Multi-Point Latch	•	•			
Self Latching Lock					•
Stainless Adjustable Rollers					•
Thermal Frame	•	•	•	•	•
Sill Pan	•	•	•	•	•
Tiered Glass Stops				•	
Glass Anchor			•		
Glass Anchor Cover			•		
Inside Glaze Option		•	•	•	
Integral Nail-Fin Frame	•	•	•	•	•
Fixed Corner-No Post	•	•	•	•	
Fixed Raked & Geometries	•	•	•	•	•
Casement, Awning, Hopper	•	•			
Horizontal Slider					•
Single Hung					•
Window-Wall & Inserts			•	•	
High Performance Options					•
Divided Lites	•	•	•	•	•
Ultravue Screen Mesh	•	•			•
Patent(s) Pending	•				
	Page 32	Page 34	Page 36	Page 38	Page 40

SERIES 450-T

CASEMENT, AWNING & HOPPER



TYPICAL CONFIGURATIONS

- C, CC, COC, A, AA, AOA, H, HH.
- Maximum Panel Square Footage: Casement, Awning & Hopper: 24 ft².
- Partner Products: Series 4800-T and 3800-T.



EXAMPLE SHGC

²NFRC
0.26

³S.P.A.
0.30



EXAMPLE U-FACTOR

²NFRC
0.23

³S.P.A.
0.22

Elevation View: C

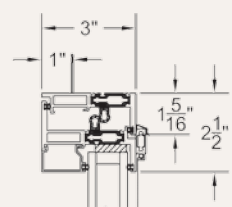

Nail-On Head Casement

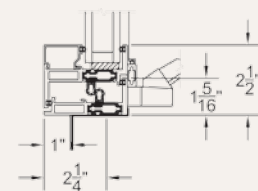

Nail-On Sill Casement

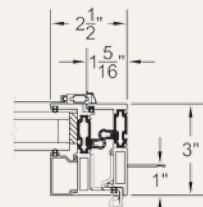
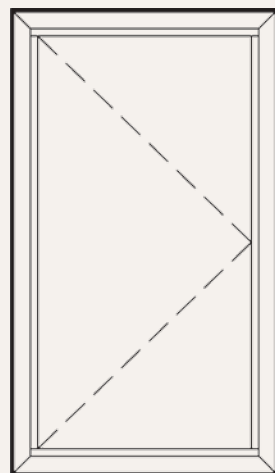

Nail-On Jamb at Hinge

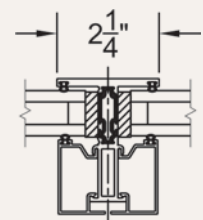

TDL

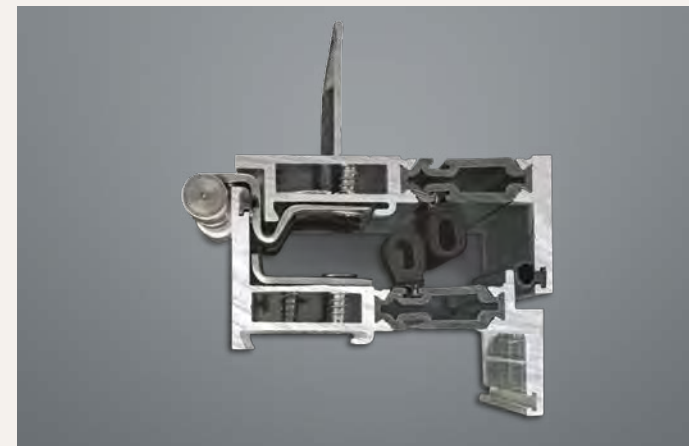

CUBE DESIGN

Our design engineers needed two years to create our next generation casement window, and the result is architectural excellence. The wall-to-glass dimension at only 2-1/2" is the slimmest on the market. An added element is its modern cube appearance and how the frame and vent intersect to eliminate distracting transitions of metal and vinyl.

ARTISTIC SYMMETRY

One feature of the cube design is a 3/16" shadow line that traces the interior and exterior. The sill shadow line is also functional, as it conceals weep slots and provides a linear drain. The complementary fixed window system carries this shadow line for a consistent linear progression when combining operable and fixed on the same elevation.

CONVECTION BLOCKERS

The 450-T was created with 'convection blockers' to maximize the natural insulation of air. The blockers are comprised of low thermal conductivity materials and divide the extruded hollows into smaller chambers, thereby slowing thermal conductivity. Combined with our proprietary strut, the 450-T is an exceptional energy performer.

PROPRIETARY CAM HANDLE & MULTIPOINT LATCH

The Archetype multi-point latch was engineered for the 450-T as the perfect complement to the Archetype cam handle. Both were designed with an ideal balance of minimal design and ergonomics. Made from high-grade stainless steel and crafted with care, together they are a work of art that complement the crisp and linear shapes of the 450-T.

²Specimen size: Nom. 24" x 59".

³Simulated Performance Alternative size: 48" x 72" casement using Cardinal 272/Argon/Clr/Argon/180 triple glazing.

SERIES 250-T

CASEMENT, AWNING & HOPPER

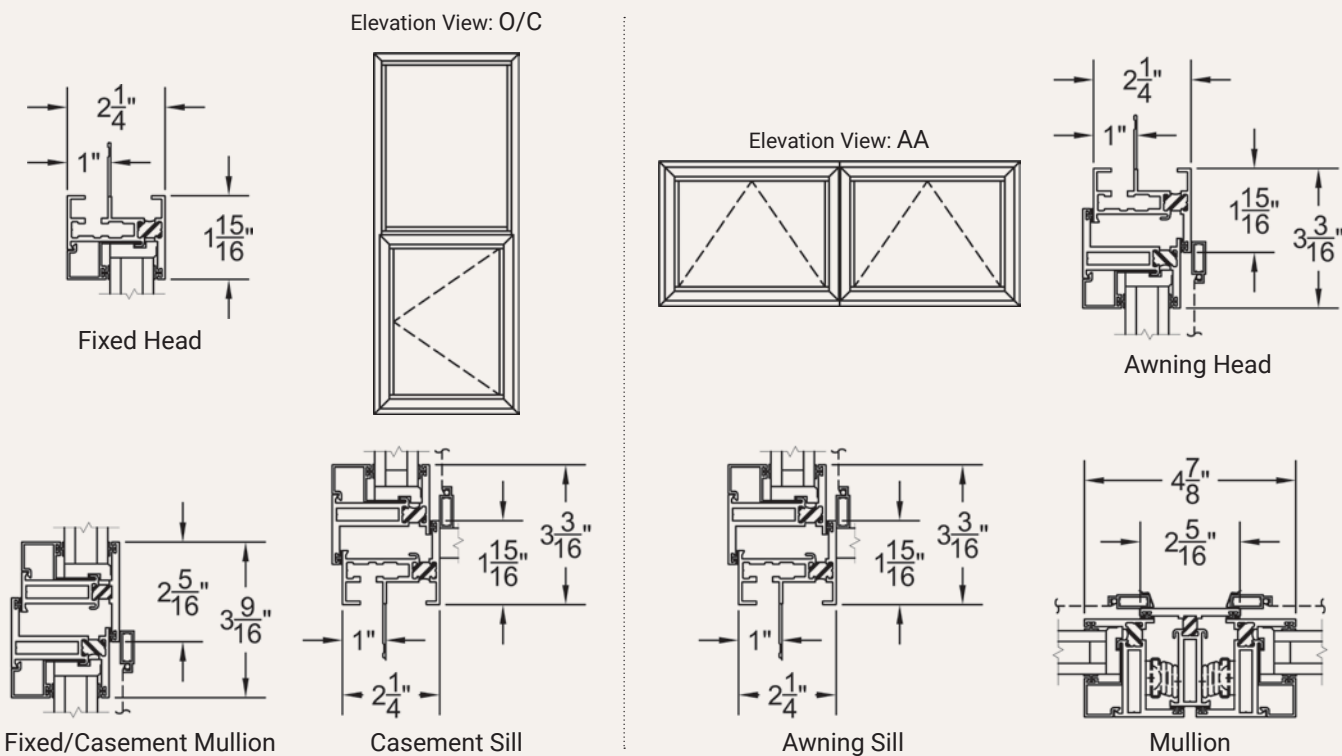

Photo by Holly Lepere

TYPICAL CONFIGURATIONS

- C, CC, COC, A, AA, AOA, H, HH.
- Maximum Panel Square Footage: Casement, Awning & Hopper: 24 ft²
- Partner Products: Series 3800-T Fixed System, Series 250 Slider, Single Hung, and Fixed Windows.

EXAMPLE SHGC		EXAMPLE U-FACTOR	
² NFRC	³ S.P.A.	² NFRC	³ S.P.A.
0.14	0.15	0.39	0.34



²Specimen size: Nom. 59" x 24".

³Simulated Performance Alternative size: 72" x 36" awning using SNX62/Argon/SNX62/Argon/IS20 triple glazing.



WELDED CORNERS

Typical residential casement windows have screw-joined corners, which weaken over decades as the windows are operated. However, Fleetwood welds the vent corners for lifetime performance. For added strength, each corner includes an aluminum extruded corner key that is crimped using a hydraulic press and welded into place.



HINGED SCREEN

This heavily engineered screen features a magnetic keeper & latch, and neoprene bulb as the bug guard. Hinges are mounted top and bottom for casements and left-top and right-top for awnings. This feature is only offered with the 4-bar hinge option, which is what the factory recommends for coastal and high wind projects.



NARROW BUTT HINGES

Each casement butt hinge is 3" long, 7/16" in diameter, and constructed of #316 stainless steel. For maximum coastal protection, each hinge is electro-polished and then brush finished. For an even cleaner profile, we offer a concealed 4-bar hinge and cam handle hardware.



STEEL LOOK APPLIED GRID

The 250-T, as well as several other products, offers this feature, which resembles a steel window yet retains all the advantages of aluminum.

SERIES 4800-T

WINDOW-WALL FIXED SYSTEM

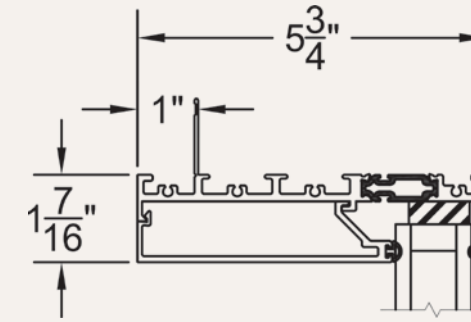

PERIMETER REVEALS & WATERPROOFING

As a luxury alternative to commercial storefront, the 4800-T frame reveals a minimal 1-7/16" sightline, and clever wall finishing can hide even more. The integral nail fin offers peace of mind during waterproofing by offering a simple 1" setback.



DEAD LOAD & SHEAR STRESS

Fleetwood's engineers designed the 4800-T glass anchor to pin the glass and provide significant lateral load (e.g. +50 DP). Support plates are provided with intersecting TDLS to support the glass weight as well as provide additional bolstering for wind loads. Each plate is constructed from stainless steel and connects with plate fasteners.

TYPICAL CONFIGURATIONS

- Virtually Unlimited.
- Optional Inserts (Casement, Awning, Hopper).
- Max Frame Height & Width Determined by Site Wind Loads.

↔ MAX PANEL WIDTH	↕ MAX FRAME HEIGHT	☀ EXAMPLE SHGC	❄ EXAMPLE U-FACTOR
Determined by Site Wind Loads	Determined by Site Wind Loads	0.24 ² NFRC	0.25 ² NFRC

Elevation View:
Window Wall with Casement

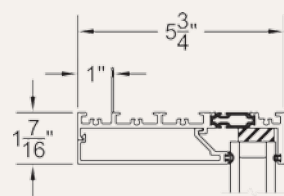

Nail-On Head

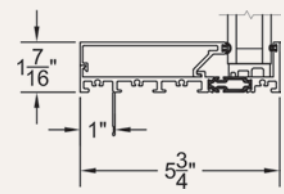

Nail-On Sill

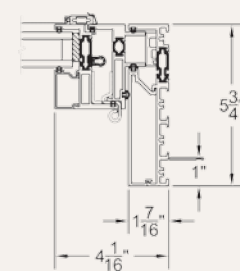
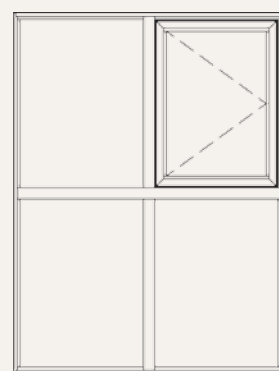

Nail-On Jamb with 450-T Insert

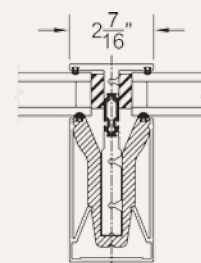

Glass Anchor & Cover

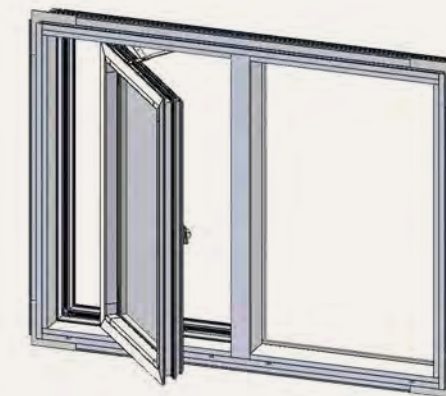

INTEGRATING WINDOWS & SLIDING DOORS

The 4800-T is specially designed to integrate 450-T operable windows. Most fixed systems glue the window frame into the opening, creating bulky frame lines and exposed caulking. Additionally, the 5-3/4" frame depth lines up perfectly with a two-track Series 4070-T or three-track 3070/3070-T.

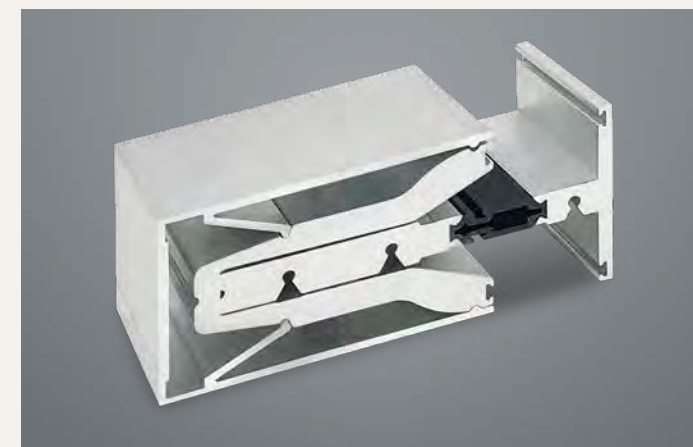

GORGEOUS TDL & HIDDEN WEEPS

Each TDL is equipped with a Glass Anchor Cover that can be installed at the project's completion so the aluminum finish is less likely to be damaged during construction. The final presentation is a TDL without seams and weep slots that are out of sight.

²Specimen size: Nom. 47.25" x 59".

SERIES 3800-T

WINDOW-WALL FIXED SYSTEM



LUXURY STANDARDS

Luxury homes demand finer details than those offered by commercial storefront. Such systems are field fabricated, including field drilled weep slots. Storefront also relies on field packed rubber into all seams and joints, resulting in uneven sightlines and gaps. In stark contrast, the 3800-T has factory punched weep slots and meets the high fit and finish standards of elite luxury.



NARROW SIGHT-LINES

The most popular feature of the 3800-T is its thin perimeter sight-line of 1-7/16" (block or nail-fin frame). Customers can choose from either an inside glaze or outside glaze orientation.

TYPICAL CONFIGURATIONS

- Virtually Unlimited.
- Optional Inserts (Casement, Awning, Hopper, Sliding, Fixed).

← MAX PANEL WIDTH	↑ MAX FRAME HEIGHT	☀ EXAMPLE SHGC	❄ EXAMPLE U-FACTOR
Determined by Site Wind Loads	Determined by Site Wind Loads	0.17 ² NFRC	0.2 ² NFRC

Elevation View:
Window-Wall With Operable Inserts

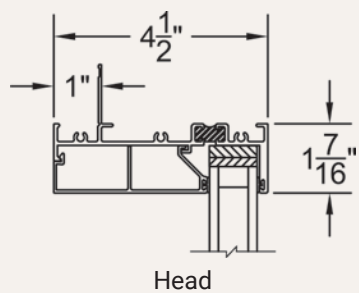

Head

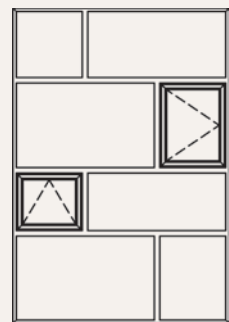

Vertical & Horizontal Tdl

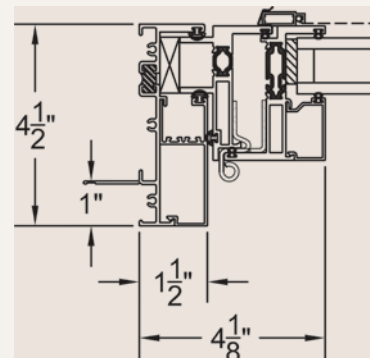

Nail-On Jamb with 450-T Insert

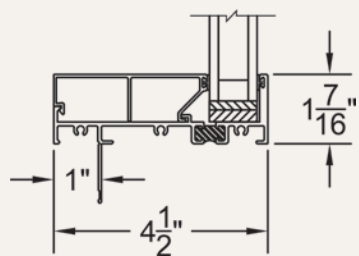

Sill

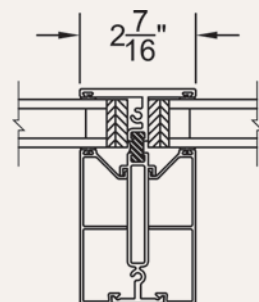

Vertical & Horizontal Tdl

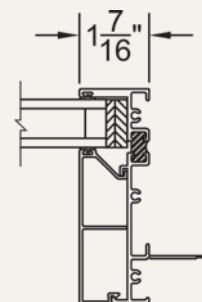

Jamb (Right)



SIGHT-LINE REDUCER

The 3800-T offers an optional glass stop to diminish the elevation sight-line. The tiered design transforms the center lines into a smaller face that draws the eye into the glass more quickly.



INSERTS & MULLING

The 3800-T offers limitless configurations and the ability to insert window and door panels. Additionally, the 4-1/2" frame depth lines up perfectly with most other Fleetwood sliding doors for seamless field mulling.

²Specimen size: Nom. 47" x 59".

SERIES 530-T

HORIZONTAL SLIDER & SINGLE HUNG



DESIGNER LATCH

True to Fleetwood form, the 530-T is equipped with our proprietary latch, proudly made in the USA and constructed of #316 stainless steel. It is a self-latching design so you only need close the window to be sure it is securely locked. This latch is available in brushed or black painted stainless.

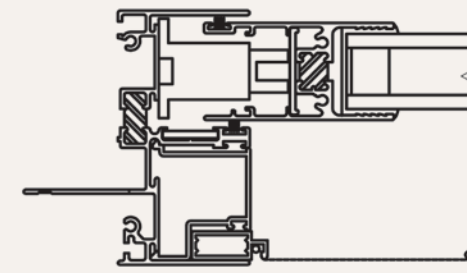

Sash Balance

SIDE LOAD SINGLE HUNG

The smooth operation and supreme stability of the 530-T is owed to the block and tackle sash balance system. The balances are concealed, affording simple, clean lines.

TYPICAL CONFIGURATIONS

- XO, OX, XOx, SH.
- Maximum Panel Width¹: Horizontal Slider: 78"; Single Hung: 58".
- Maximum Panel Height¹: Horizontal Slider: 90"; Single Hung: 45".
- Partner Products: Series 250 Glazed to Frame.

EXAMPLE SHGC		EXAMPLE U-FACTOR	
² NFRC	³ S.P.A.	² NFRC	³ S.P.A.
0.21	0.23	0.36	0.29

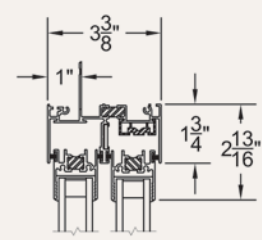

XO-Head

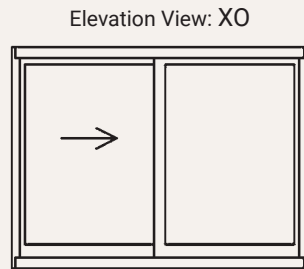

Elevation View: XO

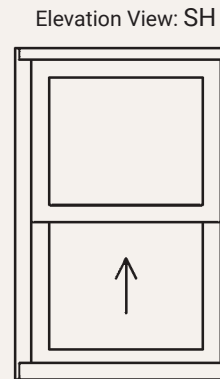

Elevation View: SH

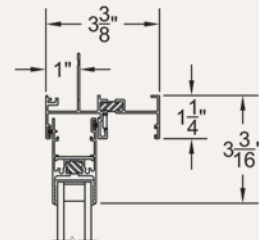

SH-Head

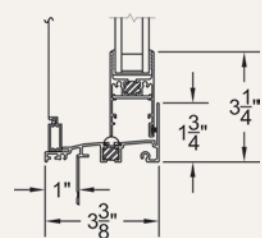

XO-Sill

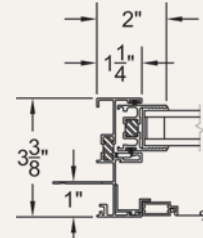

XO-Sliding Jamb

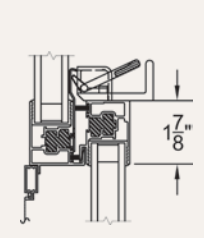

SH-Interlocker

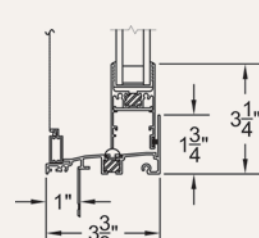

SH-Sill

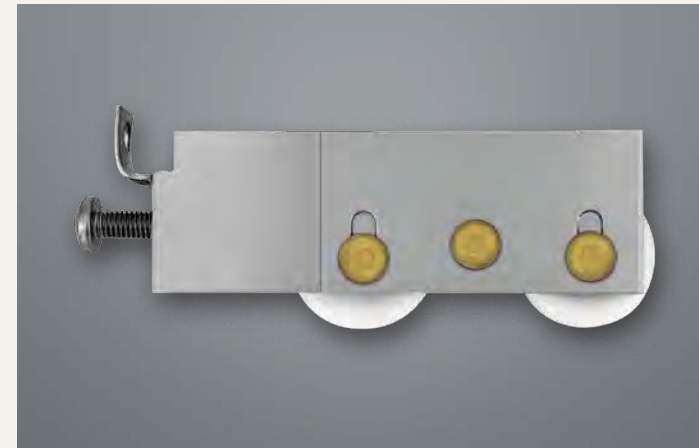

TANDEM ROLLERS

The 530-T rolling system stands alone in the market as the only sliding window with an adjustable tandem roller. This small but capable roller is constructed of stainless steel with nylon tires and can carry up to 75 pounds of weight.

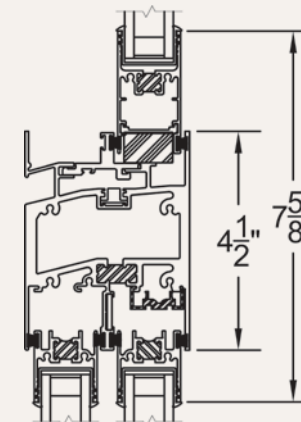

HIGH PERFORMANCE CAPABILITY

For applications requiring high performance windows, the 530-T has the answer with a variety of options that increase its strength, including: an HP integral stack bar, HP interlockers, and a high water sub sill.

¹Max width and height are not necessarily available in combination.

²Specimen size: Nom. 59" x 47".

³Simulated Performance Alternative size: 144" x 90" XO using Cardinal 366-i89/Argon glass.

ALUMINUM FINISHES

One of the unique traits of aluminum is its ability to have multiple finishes. If properly maintained, these finishes will last a lifetime. We offer more information on our website (Homeowners/Right Choices).

ANODIZING is a permanent chemical conversion process. Aluminum extrusions are exposed to a series of electrochemical baths, which create a hard, protective layer that can be left 'clear' or organically dyed to Light Bronze, Medium Bronze, and Dark Bronze colors. While anodizing cannot be as visually uniform as paint, it yields a much richer and livelier 'depth' of color and finish.

The custom Light Bronze and Medium Bronze colors (below) inherently exhibit color variation from part-to-part, as well as color-shifting depending upon viewing angle and lighting. Anodized finishes are always at least somewhat transparent and therefore expose underlying aluminum grain and character similar to a stain-finish on wood. As such, an acceptance range is necessary for these two colors (see range below). If color uniformity is required on your project, Fleetwood offers 70% Kynar painted finishes (opposite page).

STOCK ANODIZE FINISHES

Fleetwood offers two stock anodized colors:

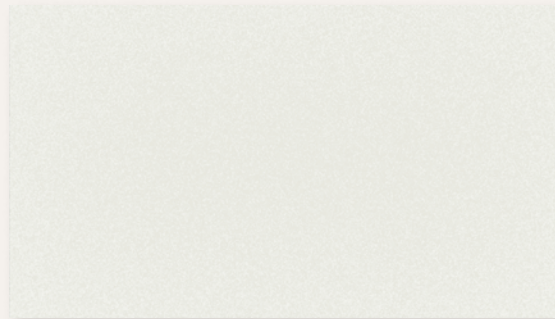

Class I Clear



Class I Black

CUSTOM ANODIZE FINISHES

Fleetwood offers two custom anodized colors.

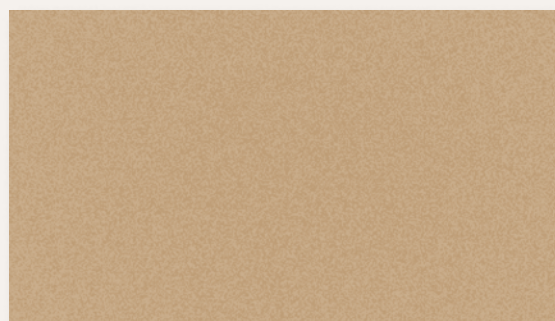

Class I Light Bronze

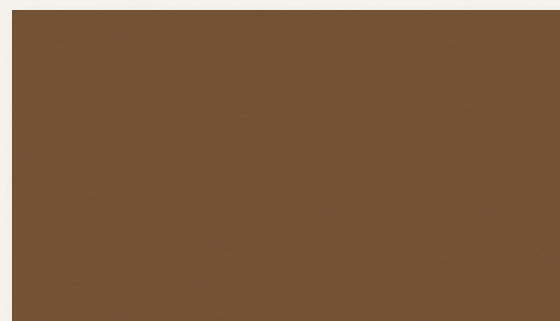

Class I Medium Bronze



The anodized colors shown above are *not actual anodize*, but resemble the anodized colors as closely as possible within the limitations of printed reproduction. Actual anodized samples are available upon request.

The **PAINTING** Fleetwood offers is a process involving high performance liquid paint (Kynar 500®) and an electrostatic process for even coverage. Some aluminum products are painted with powder coating but do not be fooled into thinking it is as good as Kynar 500®. Some powders consist of the same high performance pigmentation as Kynar 500® but most do not. Consider this: there are only a handful of licensed applicators to spray Kynar 500® but there are thousands of powder coaters.

THOUSANDS OF COLORS! THE PROCEDURE FOR COLOR SELECTION IS EASY.

SELECTING A FAVORITE COLOR

Select a "Favorite Color" from those shown below.

SELECTING ANOTHER COLOR

Any store that sells paint will display catalogs of paint colors. Each color is assigned a UC number, which indicates the specific recipe used to create the color. Provide the color name and UC number to our dealer and we will take it from there.

SELECTING A COLOR YOU CREATED

If you prefer a color that does not exist then you can create your own! Simply provide us with a physical sample of the desired color, and our painter will match it.

During confirmation of your order, we will furnish an aluminum color sample for you to approve so you are certain it is the color and gloss you want.

PAINTED ALUMINUM FINISHES | 12 OF OUR CUSTOMERS' FAVORITE COLORS

Kynar 500® (Kynar 70% Standard 2-Coat)

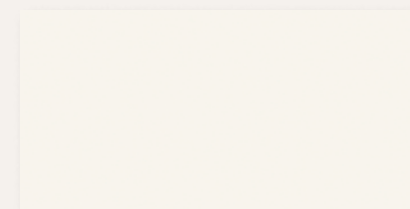

White #10

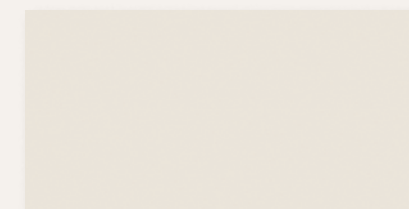

Bone White

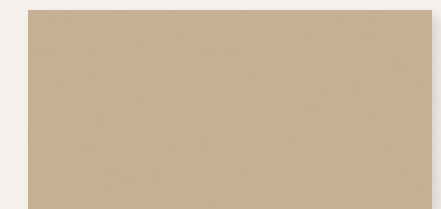

Beige



Light Seawolf



Medium Bronze

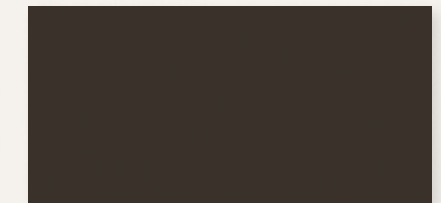

Statuary Bronze



Charcoal Gray

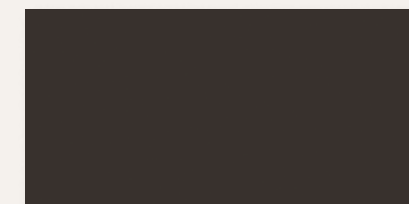

Black Beauty

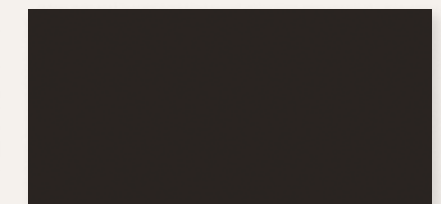

Rich Black

Kynar 500® Specialty Coatings (Kynar 70% Exotic)

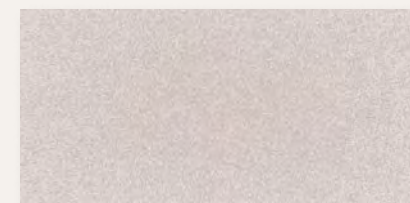

Silver, Mica 2-Coat



Brite Copper, Metallic 4-Coat

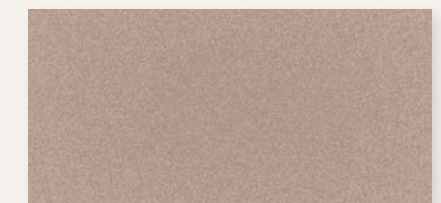

Champagne Sunstorm, Mica 2-Coat

The painted colors shown above are *not actual paint*, but resemble the painted colors as closely as possible within the limitations of printed reproduction. Actual painted samples are available upon request.

Kynar 500® is a registered trademark of Elf Atochem North America, Inc. Minimum of 70% fluoropolymer resin for premium performance in solid colors. Two-coat system: Corrosion inhibiting primer at 0.2 mil and durable high performance topcoat at 1.0 mil. Minimum total dry film thickness of 1.2 mil. Hardness: F minimum. · Meets or exceeds AAMA 2605. · Gloss: Medium (25-35 @ 60).

STEEL LOOK OPTIONS



Fleetwood offers a Steel Look simulated divided lite option in all product families for projects desiring the look of steel but for which aluminum is the better choice. Recommended Steel Look products include the Series 3200-T, 3800-T, and 250-T.

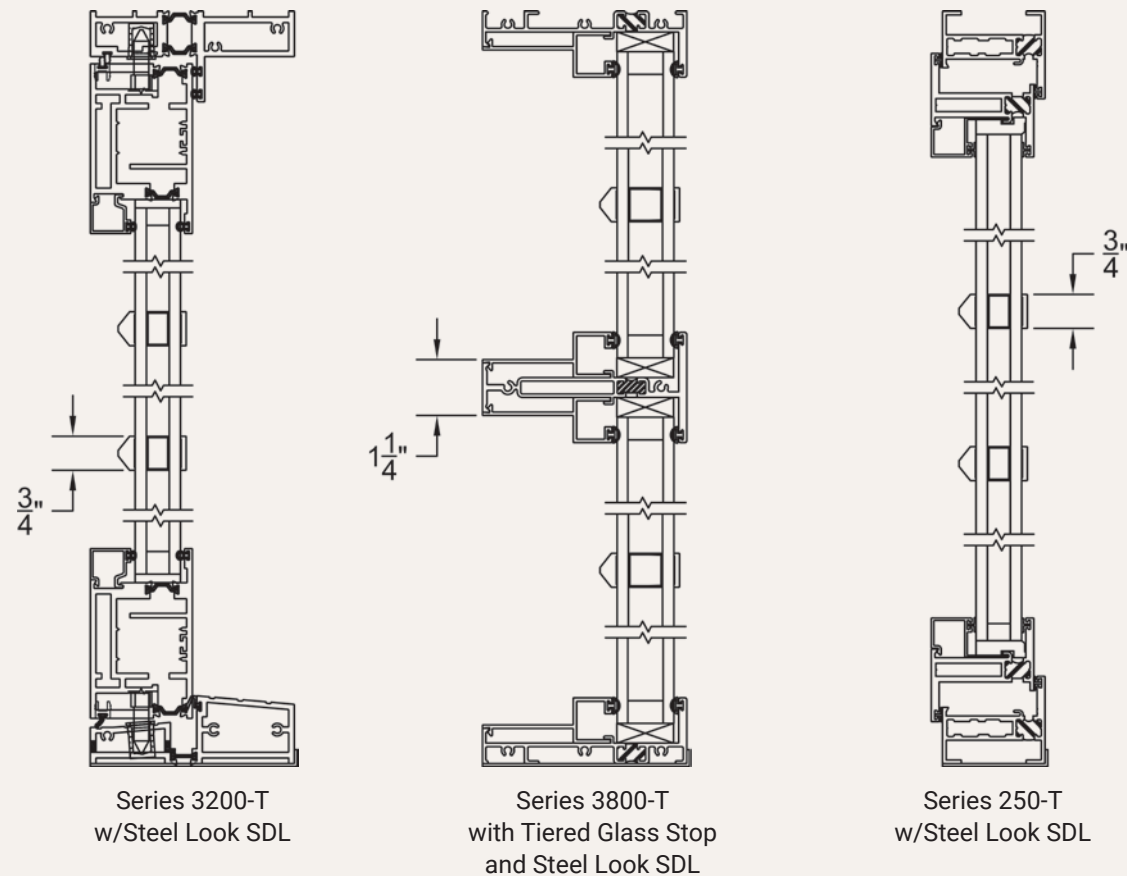

HINGED DOOR “LOCK BOX” STYLE
The Series 3200-T hinged door is offered with an applied box to provide an appearance similar to a classic steel door style. Though not as slender as steel, the scale of the ‘lock box’ is a respectable alternative when steel is not right for the project.



SHADOW BOX TIERED STOP
For applications when a deeper presentation is desired, the Series 3800-T Tiered Stop option is ideal. Customers may opt for an array of only tiered stops intersections or a combination of tiered stops and SDLs.

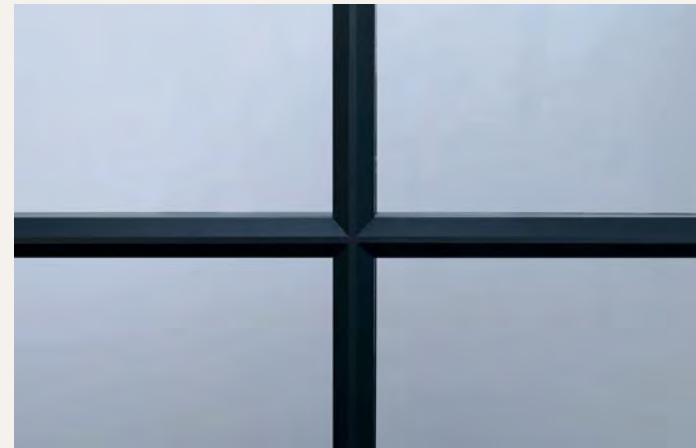

CASEMENT, AWNING & FIXED WINDOWS
The Series 250-T is available with the Steel Look SDL (Simulated Divided Lite) feature. Customers may choose from casement, awning, or fixed configurations and can create numerous custom lite arrangements.



INHERENT DESIGN STEP
Whether choosing the Series 3200-T, 3800-T or 250-T, the perimeter glass stop/SDL segue is purposely stepped to create a tasteful flow from flush frame to glass surface.

DOOR HARDWARE

Most Fleetwood hardware is crafted from high-grade stainless steel (S.S.) and several parts are treated with an electro-polished finish for paramount coastal protection. All hardware shown is brushed texture, except where otherwise noted.

A-ARCHETYPE LOCKING SYSTEM

MULTI-SLID E/POCKE T DOORS: SERIES 4070-T, 3050, 3070-T, 3070, 3070-HI
TRADITIONAL SLIDING DOORS SERIES 3000-T, 3000



Archetype - S.S.



Archetype - S.S.
(Black Paint)



Archetype Narrow - S.S.



Archetype Narrow - S.S.
(Black Paint)



Strike Plate - S.S.

ARCHETYPE ROLLERS & TRACK



A4 - S.S.
Swiss Precision Bearings
(Series 4070-T)



A3 - S.S.
3" diameter
Swiss Precision Bearings
(Series 3050, 3070-T, 3070)



A2 - S.S.
2" diameter
Swiss Precision Bearings
(Series 3000-T & 3000)



Track Insert - S.S.
(Shown in 2 track 3070 sill)

ARCHETYPE MULTI-SLIDE DOOR OPTIONS



Actuator Lever - S.S.



Door Collectors - S.S.



Edge Pull - S.S.

HINGED DOOR: SERIES 3900-T



FSB Lever
#1076 - S.S.



FSB Lever
#1075 - S.S.



FSB Lever
#1005 - S.S.



Savio Butt Hinges - Aluminum
(Anodized Finish)

HINGED DOOR: SERIES 3200-T



FSB Lever
#1076 - S.S.



Flush Bolt Latch -
S.S. and others



Adjustable Hinge - Aluminum
(PVD Finish)

PIVOT DOOR: SERIES 4400-T



Fritsjurgens Closer - S.S.

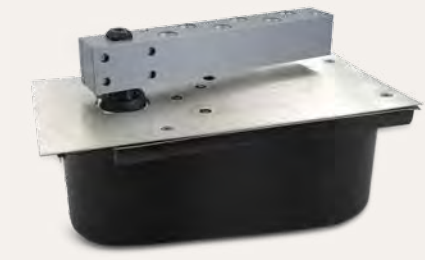

Rixson Floor Closer - S.S. and others

FOLDING DOOR: SERIES 3600-T



DPL Handle - S.S.



Bottom Pivot - S.S.



Top Pivot - S.S.



Hinge Handle - S.S.



Intermediate
Guide - S.S.



Intermediate
Carrier - S.S.

Please note: Images are not to scale.

WINDOW HARDWARE

Most Fleetwood hardware is crafted from high-grade stainless steel (S.S.) and several parts are treated with an electro-polished finish for paramount coastal protection. All S.S. hardware shown is brushed texture.

CASEMENT



Cam Handle - S.S.
(4-Bar Hinges)
(Series 450-T)



Multi-Point Latch - S.S.
(Series 450-T)



Folding Rotogear¹
(Butt Hinges)
(Series 450-T & 250-T)



Cam Handle - S.S.
(4-Bar Hinges)
(Series 250-T)



Multipoint Latch¹
(Series 250-T)

CASEMENT, AWNING & HOPPER: HINGES



Butt Hinge - S.S.
(Series 450-T)

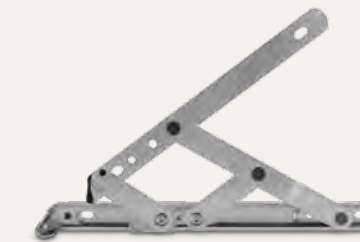

4-Bar - S.S.
(Series 450-T & 250-T)



Butt Hinge - S.S.
(Series 250-T)

Availability of hinges is based on operator type.

AWNING



Cam Handle - S.S.
(4-Bar Hinges)
(Series 450-T)



Multi-Point Latch - S.S.
(Series 450-T)



Folding Rotogear^{1,2}
(4-Bar Hinges)
(Series 450-T & 250-T)



Cam Handle - S.S.
(4-Bar Hinges)
(Series 250-T)



Multi-Point Latch¹
(Series 250-T)

SCREENS



Hinged Screen
(Series 450-T & 250-T Casement & Awning)



Flat Screen
(Series 450-T & 250-T)



Sliding Window Screen
(Series 530-T)

HOPPER



Spring Latch - W.Brz
(4-Bar Hinges)
(Series 450-T & 250-T)



Ring Cam - S.S.
(4-Bar Hinges)
(Series 450-T & 250-T)



Pole - W.Brz
(Series 450-T & 250-T)

SLIDING & SINGLE HUNG



Strike & Latch - S.S.
(Series 530-T)



Roller - S.S.
(Series 530-T)

¹ Cast zinc (plated finish).

² Limited vent travel.

GREEN & SUSTAINABLE

It is estimated that over 8% of the earth's crust contains bauxite ore, which is naturally rich in aluminum oxide ("alumina"). The world was aware of this as early as the Babylonian Empire but was unable to efficiently isolate aluminum. It was not until the late 1800's that an American scientist, Charles Martin Hall, discovered the process that changed the world:

ALUMINUM PRODUCTION

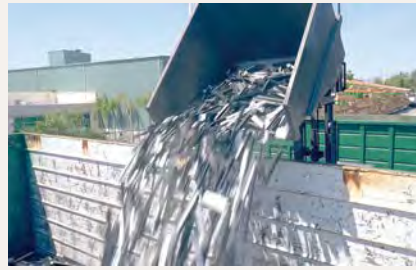

ECO-FRIENDLY

Fleetwood Windows & Doors is continually making efforts to be "Green Friendly" and currently leads the fenestration market with the **Greenest** multi-slide and sliding pocket doors in the United States. Our aluminum products are manufactured using **recycled aluminum and glass** and offered in inert coatings and finishes.



STEP 1: MINING

Bauxite is mined and gathered.



STEP 2: REFINING

Bauxite is finely ground and mixed with lime and caustic soda which produces a sugar-like white powder called "alumina" (also known as aluminum oxide).



STEP 3: SMELTING

The alumina is dissolved in a cryolite bath. During this molten state, a powerful electric current is passed through the bath and aluminum is separated from the chemical solution and powerful machines siphon off the aluminum.



STEP 4: FABRICATING

Aluminum is placed into a furnace where it is melted down and mixed with other metals to produce customer specified alloys. These molten mixes are then poured into ingots which harden and then are shipped for further fabrication, such as extruding.

ALUMINUM is a fantastic building product for those concerned about sustainability. It is naturally plentiful and perpetually surviving. Moreover, aluminum rates very high in Life Cycle Assessment and leaves a small ecological footprint. All windows and doors eventually must be replaced but aluminum windows and doors last decades longer than wood and vinyl. Consider the impact on the world's landfills with all the wood and vinyl waste.

Additionally, imagine the wasted energy on redundant manufacturing of short-lived wood and vinyl windows and doors. For more information about why Fleetwood products are a wise choice for the environmentally conscious homeowner, please see our Green & Sustainable document online at www.FleetwoodUSA.com, under the Products menu.

FACTORY & SHOWROOM



We invite you to visit our 207,000 square foot factory which is located in Southern California. Our Showroom is equipped with a broad sampling of every product we manufacture. Contact one of our authorized dealers to set up an appointment.

FINDING A DEALER

If your project is located in one of our major markets (Hawaii, California, Nevada, Arizona, New Mexico, Colorado, Utah, Oregon, Washington, Idaho, Texas, Tennessee, Alabama, Georgia, South Carolina, North Carolina, Florida, New York, Illinois, British Columbia and Mexico), we offer a convenient way to find a dealer. On our website, follow the DEALERS menu to the Dealer Search page to find a dealer near you.

IMPORTANT

The Transferable Lifetime Warranty and Care & Maintenance Instructions are available on our website.

BUDGET PRICING

If your project is located outside our major markets, we offer an alternative method for a price quote. On our website, follow the PRODUCTS menu to the Budget Pricing page. Our Inside Sales staff will process your quote within 72 hours.

MORE INFORMATION?

We encourage you to visit our website at www.FleetwoodUSA.com.

*Authorized Dealers can buy glass to install in Fleetwood products. If you desire factory glazing and the subsequent glass warranty, make sure the dealer is providing factory glazed doors and windows.



Conformance to:
AAMA/WDMA/CSA 101/I.S.2



Fleetwood Windows & Doors
1 Fleetwood Way, Corona, CA 92879
P.O. Box 1086, Corona, CA 92878-1086
800.736.7363
951.279.1070
www.FleetwoodUSA.com
Sales@FleetwoodUSA.com

DISTRIBUTED BY:



All detail subject to change without notice. November, 2019.
Copyright © 2019 Fleetwood Windows & Doors. All rights reserved.